

Remove and install final drive,  
refer to 33 10 010.

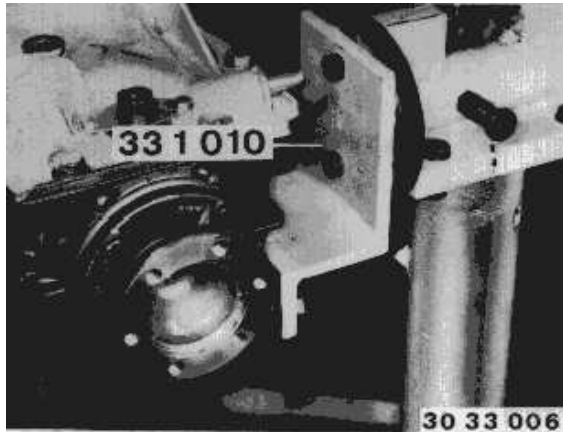

Secure final drive to special tool 33 1 010 (retaining bracket).  
Drain off fluid. Take off case cover.

**Installation:**

Replace seal.  
Tightening torque, refer to Technical Data.  
Top up oil.  
Oil quantity, refer to Technical Data.  
Oil grades,  
refer to BMW Service Operating Fluids.

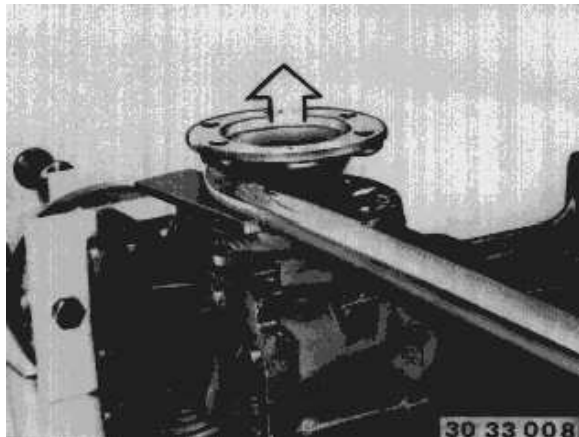

Press off both drive flanges with a tire iron.

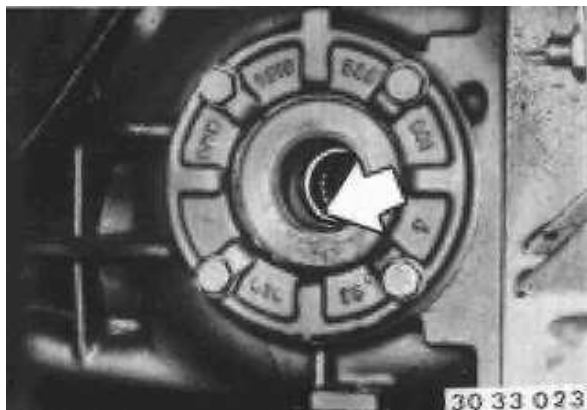

**Installation:**

Before fitting the drive flange, insert a round wire circlip in  
the groove of the differential housing in such a way that  
both ends are recessed in the groove.

This prevents lateral bending of the ring.

Press in drive flange by hand and turn slightly until wire snap  
ring is heard to engage.

Replace stretched snap rings.

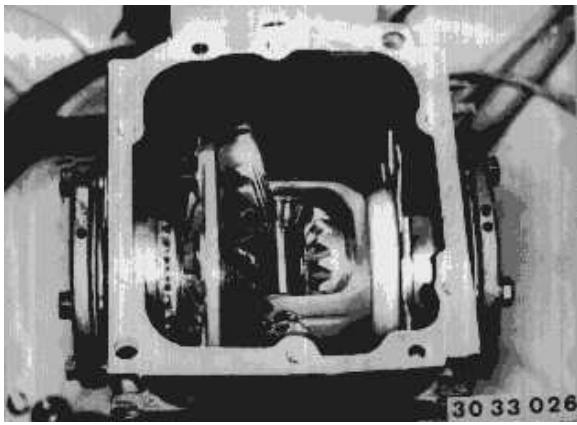

Punch mark both bearing caps. Unscrew and remove both bearing caps.

**Caution!**

Do not mix up bearing caps and spacers.

Secure spacers on bearing cap with a piece of wire, if necessary.

**Installation:**

Tightening torque,  
refer to Technical Data 31 11 2AZ.

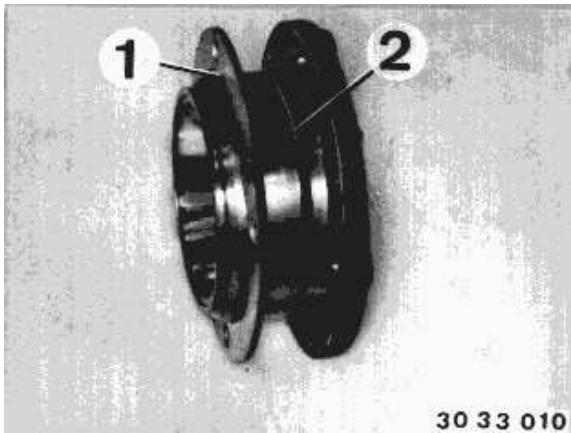

Differential housing mounts and torsional face runout are set using the shims (1).

Check O-ring (2), replace if necessary.

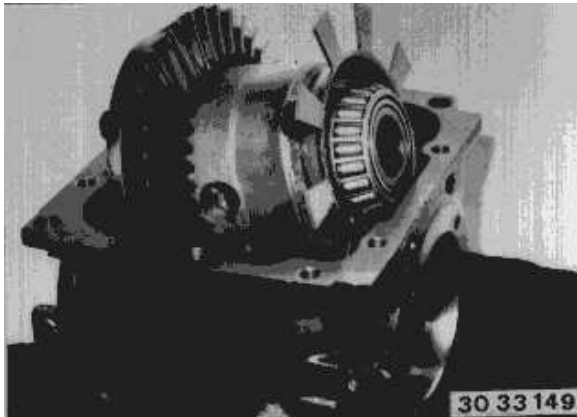

Remove complete differential case.

**Caution!**

Do not bend the pulse generator wheel.



Remove lockplate.

Unfasten nut (1) and brace with special tool 23 0 020.

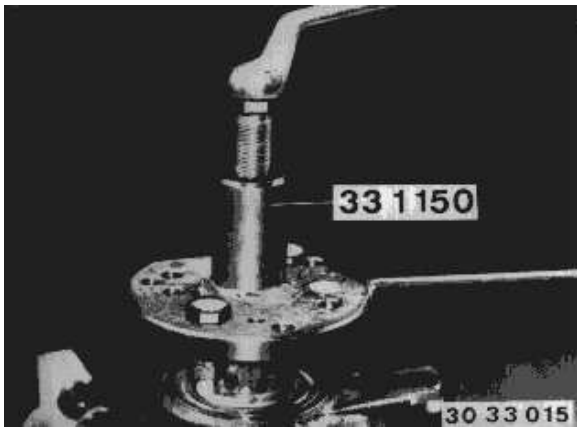

Remove input flange with special tool 33 1 150.

The specified friction torque level is indicated for the new drive pinion bearing,

refer to Technical Data.

The friction torque of the old bearings no longer needs to be measured.

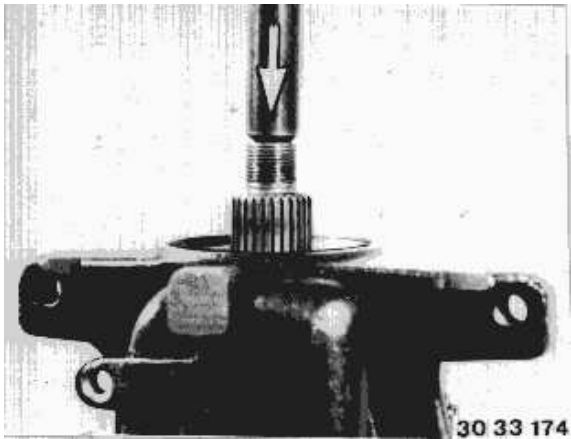

Press out drive pinion.

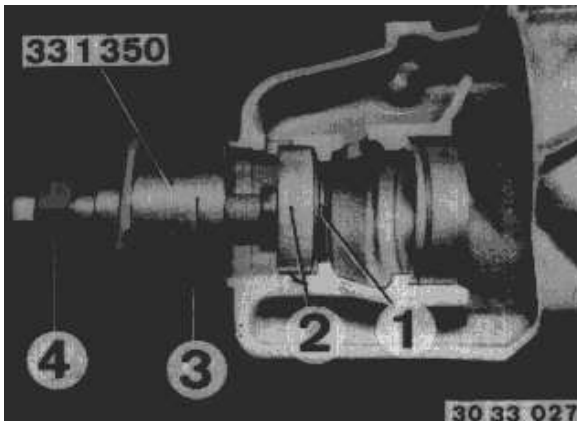

Extract front bearing outer race with special tool 33 1 350 (fixture).

- (1) Spreader
- (2) Front bearing outer race
- (3) Puller bell housing
- (4) Pressure bolt

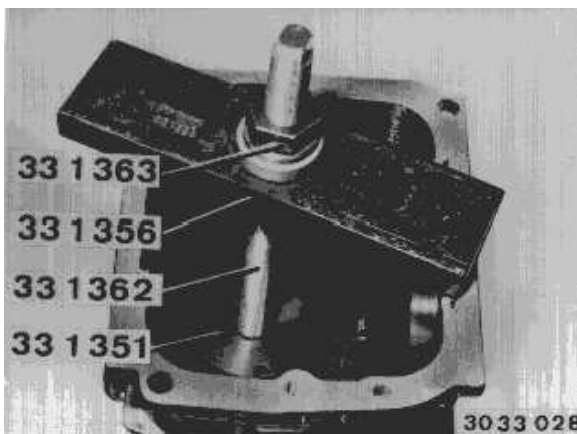

Remove rear outer bearing race with special tool 33 1 351 / 356 / 362 / 363.

**Caution!**

Shim (X) is located underneath the rear bearing outer race. It will be needed again for pinion/crown wheel adjustments.

**Caution!**

Replace both drive pinion bearings, using only one make.

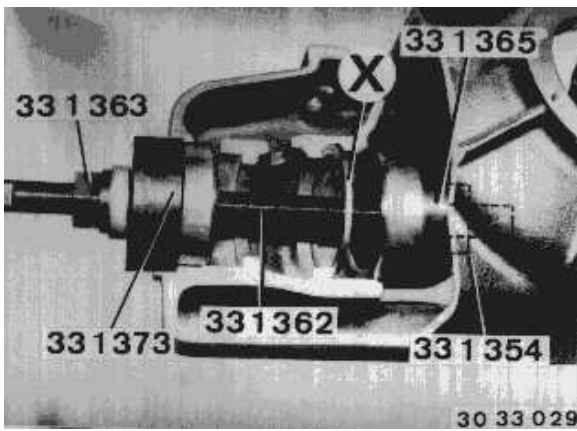

**Installation:**

Install old shim (X) in front of the rear bearing outer race.  
 Fit new outer bearing race with special tool 33 1 373 / 365 / 362 / 363 / 354.

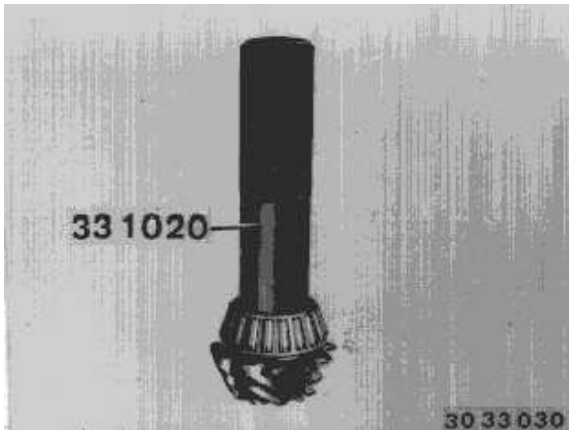

**Installation:**

Press new taper roller bearing inner races to the new drive pinion with special tool 33 1 020.

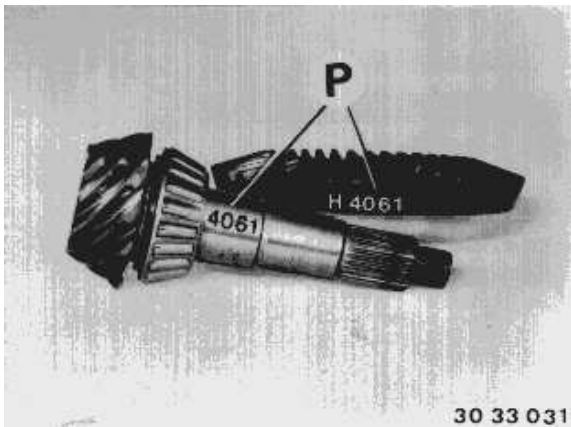

**Caution!**

Drive pinions and crown wheels are paired for optimal smooth running in special machines.

The pairing code (P) is embossed electrically on the drive pinion and crown wheel.

Never install crown wheel and drive pinion with different pairing codes (P) together.

H = Gleason hypoid teeth (helical shape).

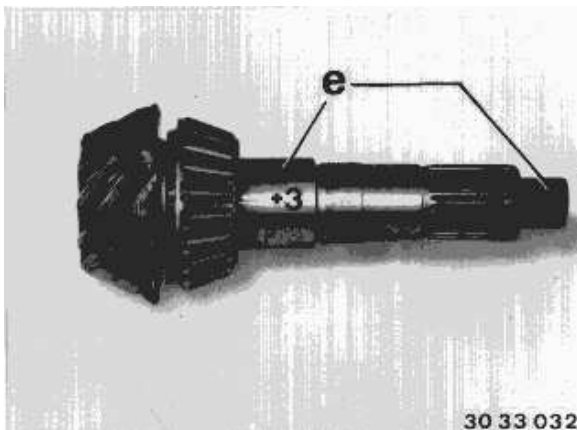

The inscribed number with "+" or "-" is the deviation from basic distance C in hundredths of millimeters and is required for adjustment of the tooth contact pattern with shims.

+ e is added to C.

- e is subtracted from C.

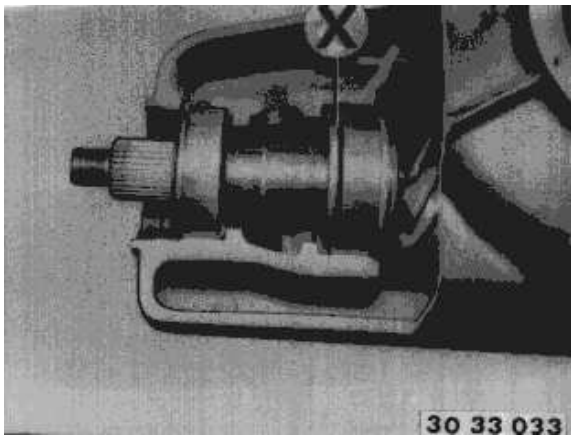

**Installation:**

To determine the thickness of the correct shim (X), install drive pinion with new tapered roller bearings, but without bush.

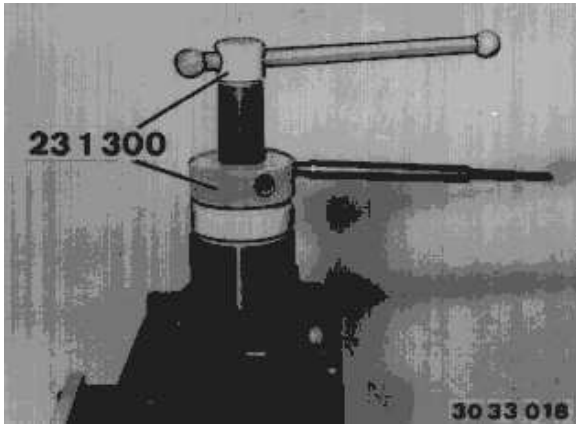

**Installation:**

Install drive pinion in the rear bearing outer race.

Press-fit front taper roller bearing to the drive pinion with special tool 23 1 300 in conjunction with a spacer bush but do not tighten down.

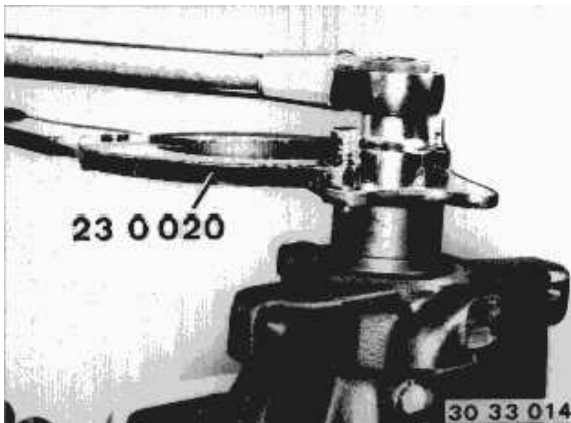

**Installation:**

Mount input flange.

Gradually tighten collar nut, occasionally measuring friction torque with special tool 00 2 000 (friction torque gauge) and adjust with collar nut to 250 Ncm.

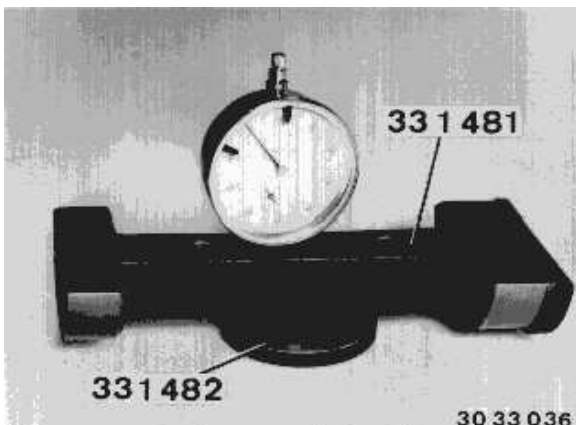

Block distance of drive pinion

Secure dial gauge in special tool 33 1 481.

Fit special tool 33 1 481 with dial gauge on special tool 33 1 482 and set dial gauge preload to zero.

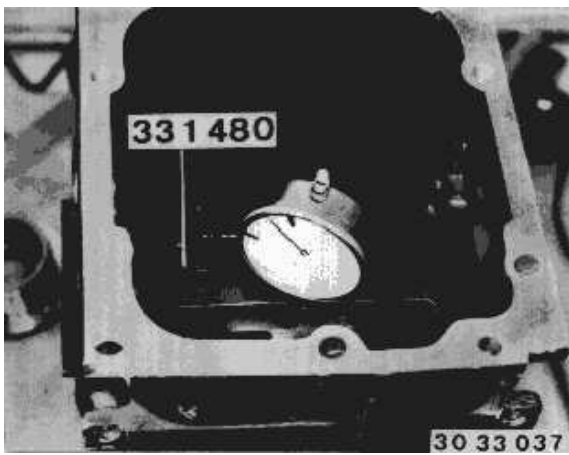

Take measurement with special tool 33 1 480.

To do so, place special tool 33 1 482 on drive pinion and insert special tool 33 1 481 in housing.

Determine value Y.

Basic distance C = 9.02 mm

Gauge thickness B = 7.00 mm

Examples for calculating the correct thickness of disc (x)

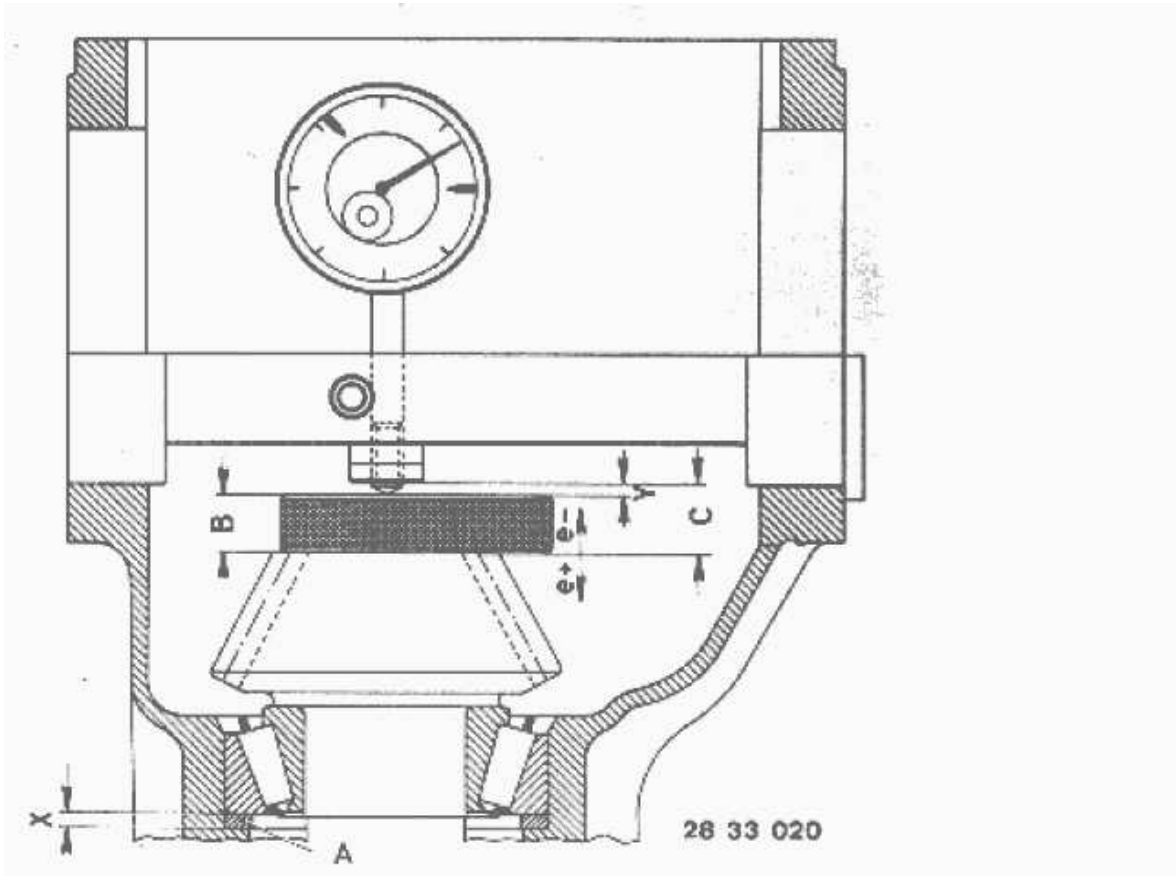

Example I:

C	9.02 mm
---	---------

e +	0.10 mm
C nominal	9.12 mm
Y measured on dial gauge	1.92 mm
+ master disc thickness	7.00 mm
C actual	8.92 mm

C nominal	9.12 mm
C actual	- 8.92 mm
a	0.20 mm
master disc A	4.10 mm
- a	0.20 mm
Thickness of shim (X)	3.90 mm

If C nominal is greater than C actual, "a" is subtracted from thickness of shim (X).

Example II:

C	9.02 mm
e -	0.10 mm
C nominal	8.92 mm
Y measured on dial gauge	2.12 mm
+ master disc thickness	7.00 mm
C actual	9.12 mm

C nominal	9.12 mm
C actual	- 8.92 mm
a	0.20 mm
master disc A	3.90 mm
- a	0.20 mm
Thickness of shim (X)	4.10 mm



If C nominal is less than C actual, "a" on the shim ring (x) is added to the value.

The permitted tolerance for dimension (x) is derived from the gauge steps available for shim rings (0.01 ... 0.03 mm).

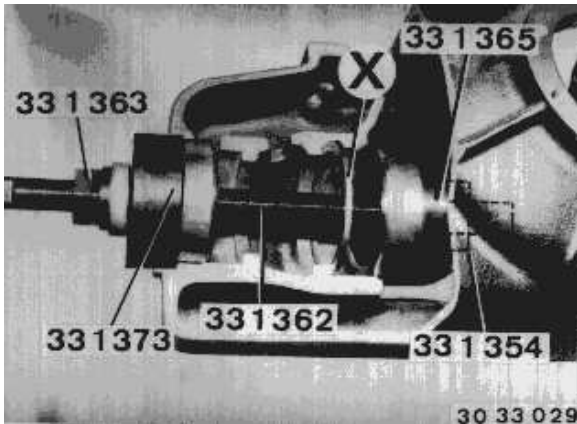

Remove drive pinion and rear bearing outer race.

Press in shim (X) of determined thickness and bearing outer race.

**Caution!**

Do not install the drive pinion, because first of all the friction torque of the new differential housing bearings must be measured and adjusted.

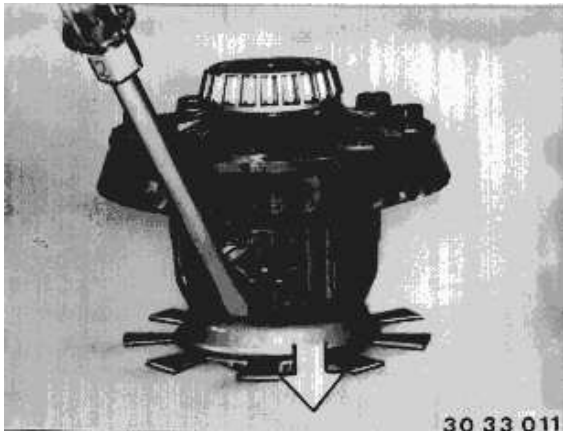

Press pulse generator wheel off of differential case.

**Caution!**

Do not bend the pulse generator wheel.

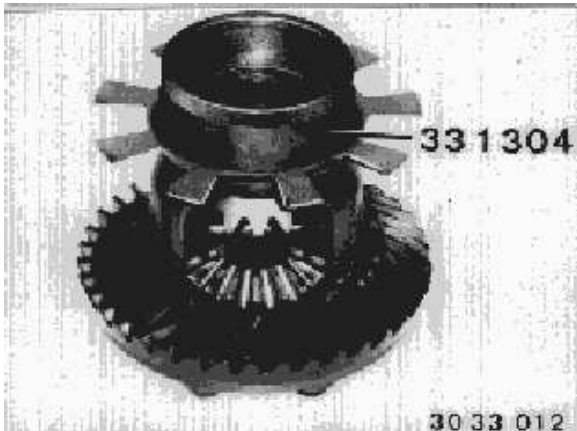

**Installation:**

Press on pulse alternator wheel with special tool 33 1 304 (union ring).

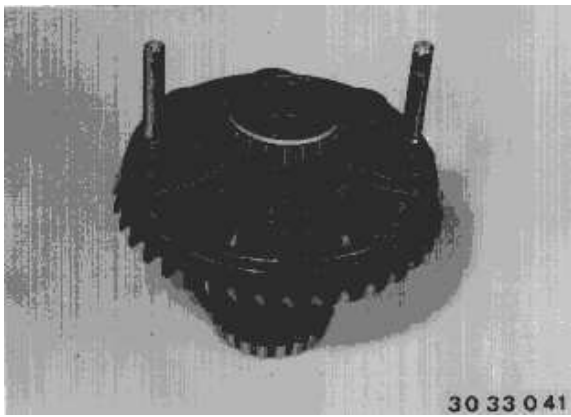

Remove crown wheel (cold).

**Installation:**

Heat new crown wheel to max. 100 °C (chrome thermo pin).

Mount crown wheel with two locally manufactured staybolts for guiding.

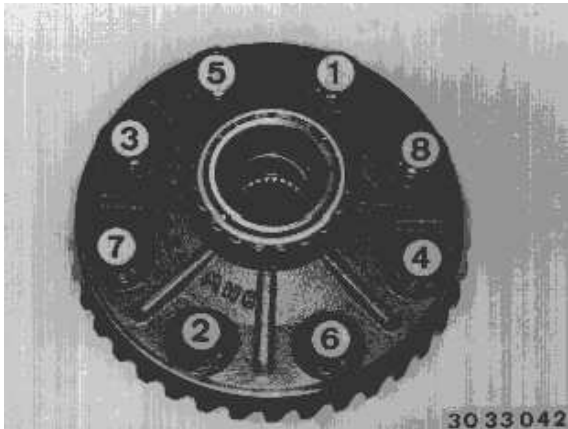

**Installation:**

Install new bolts with Loctite No. 270 and tighten in order of (1 ... 8).

Observe tightening torque and torsion angle, refer to Technical Data 33 12 1AZ.

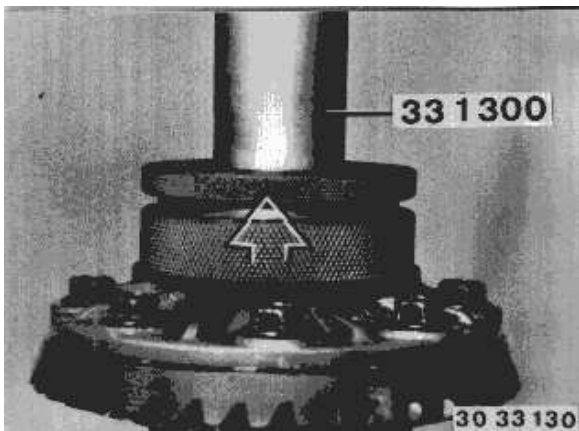

Extract taper roller bearing on final drive case with special tool 33 1 300 (extractor).

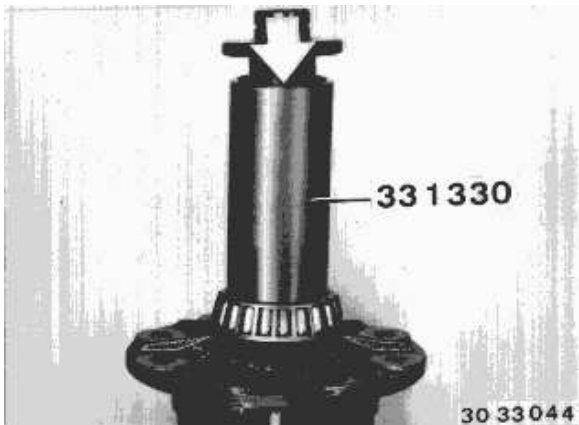

**Installation:**

Press new cold taper roller bearing inner races in with special tool 33 1 330.

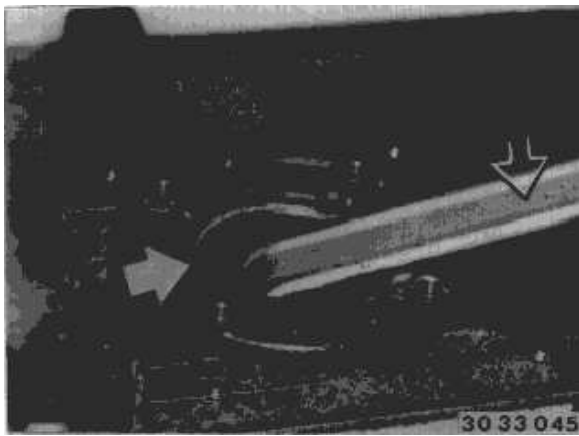

Lift shaft seals out of both bearing caps.

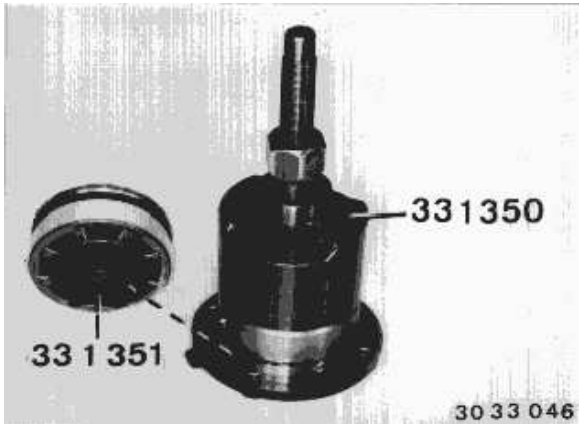

Press outer bearing race out with special tool 33 1 350 / 351.

**Caution!**

Special tool must engage in the bearing outer race.

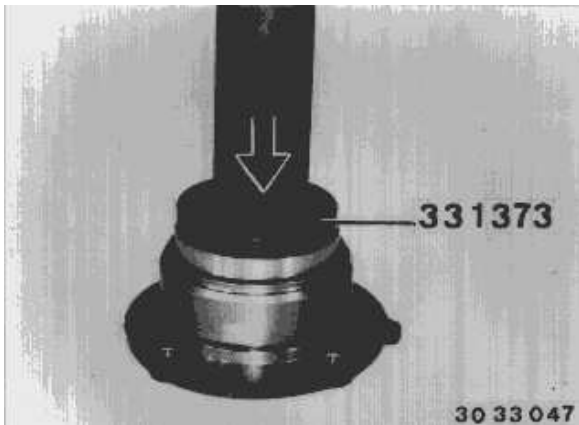

**Installation:**

Press new outer bearing race in with special tool 33 1 373.

The next 12 operations can only be omitted if the differential housing bearings are not being replaced:

Install differential housing with new crown wheel and new bearing.

Lubricate bearing thoroughly with approved final drive oil, refer to BMW Service Operating Fluids, and allow to drip.

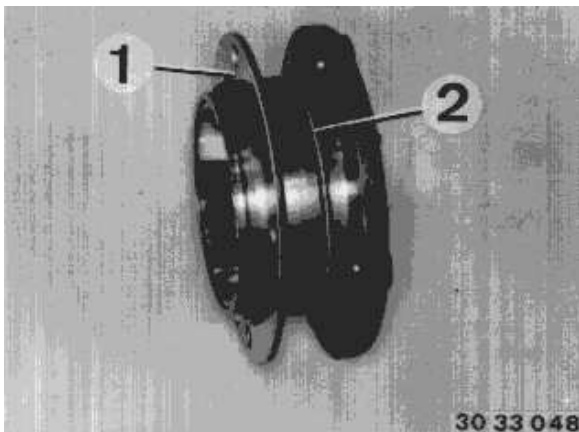

**Installation:**

Install lateral bearing cover as indicated with the appropriate shims (1), but without O-ring (2).

Uniformly tighten screws securing the bearing cover opposite of the crown wheel.

Tightening torque,

refer to Technical Data 33 11 2AZ.

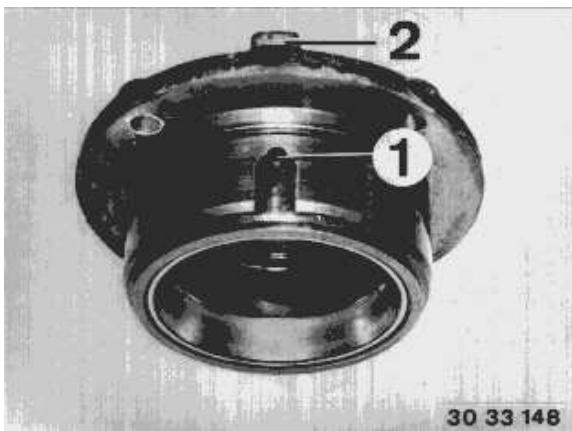

#### Installation:

Compensating bores (1), which can be identified by the outside tab (2), always face up in installed position of transmission.

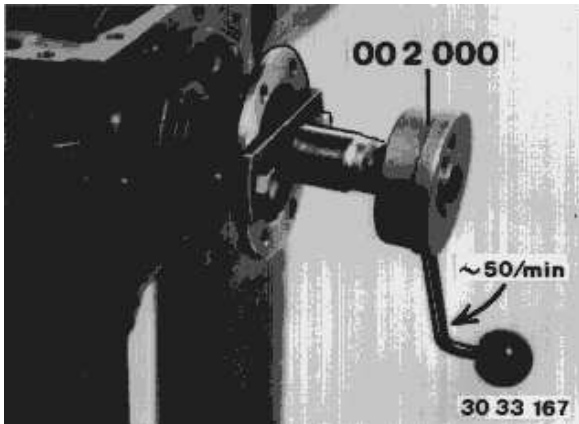

Establish friction torque level of new differential housing bearings

The axial preload force of the differential housing bearing (4000 N) can be determined from the friction torque, refer to Technical Data.

Screw in bearing cover screws of second bearing cover evenly until differential (final drive) is still just able to rotate.

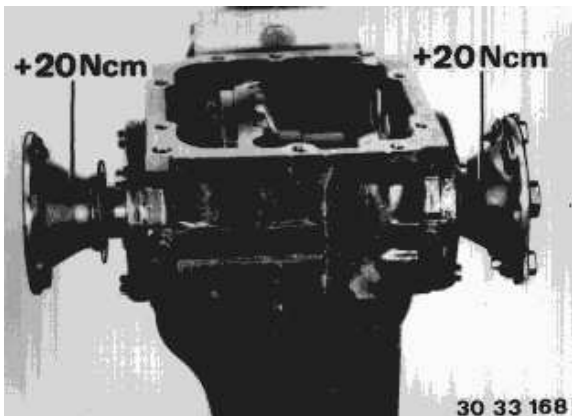

Install an output flange on the side opposite of the crown wheel. Using a bracket with welded nut (in-house manufacture) and special tool 00 2 000, establish level of friction torque.

Turn friction torque meter at speed of approx. 50 rpm.

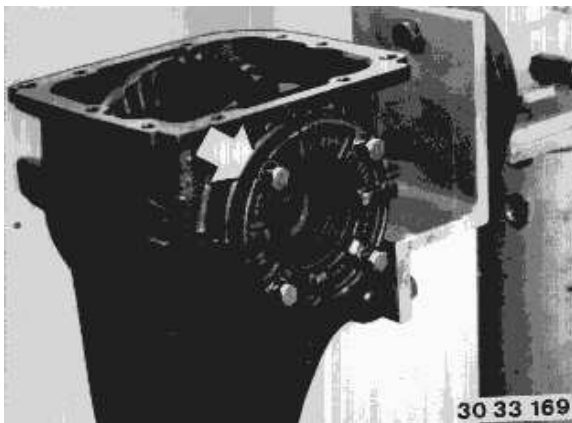

The friction torque given in the differential housing bearing table should be achieved but not exceeded.

Refer to Technical Data.

If new shaft seals have already been fitted, add 20 Ncm to each sealing ring in which an output shaft rotates during measurement.

If the specified friction torque is not achieved, although both bearing covers are tightened down to specified tightening torque, a thinner shim must be installed on the side facing the crown wheel and the measurement must be repeated.

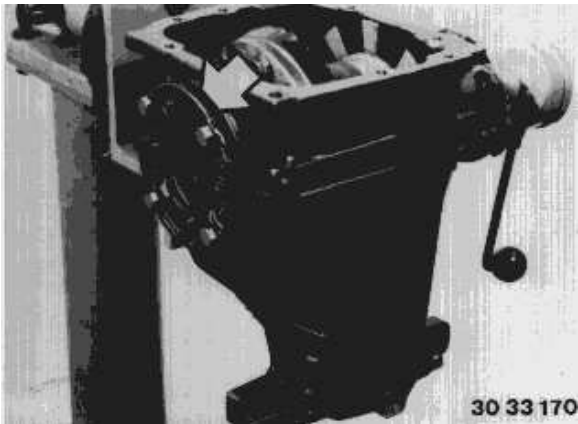

If the friction torque is reached but the second bearing cap has not yet been tightened to the specified tightening torque, refer to Technical Data, a thicker shim must be installed on the crown gear side and the measurement must be repeated.

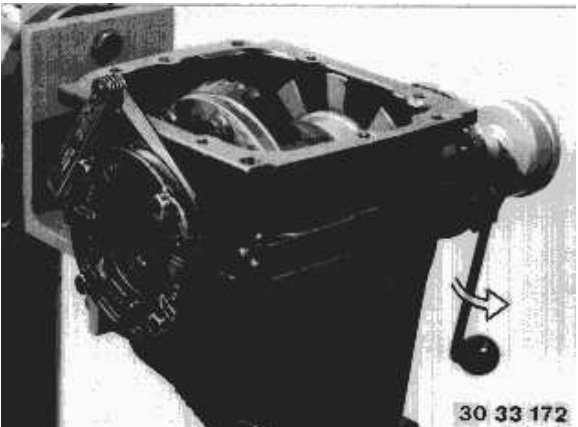

To make it easier to establish the correct shim thickness, the gap between shim and transmission case can be measured with a feeler gauge and added to the thickness of shim used.

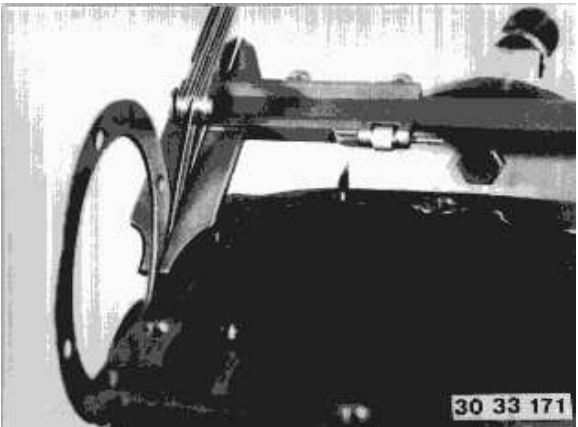

Example:

Second bearing cap not tightened (bolts screwed in uniformly).  
Friction torque (shaft seals yet installed),  
refer to Technical Data.

Gap measured with blade	0.20 mm
-------------------------	---------

Used shim	1.40 mm
New shim	1.60 mm

Install new shim with thickness of 1.60 mm and repeat measurement.

Remove final drive to install the drive pinion.  
(If the final drive case bearings were not replaced, you can continue at this point).

**Caution!**

Assign side cover to defined thickness of shim: do not confuse them.



**Installation:**

Install drive pinion with a new clamping sleeve (2).

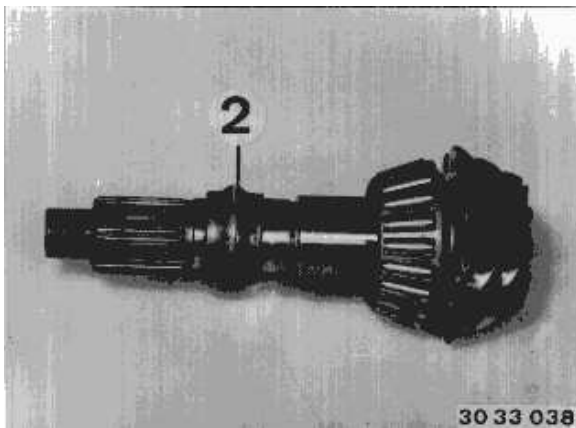

**Installation:**

Immerse shaft seal in final drive oil and drive in flush using special tool 33 1 270 in conjunction with 00 5 500.

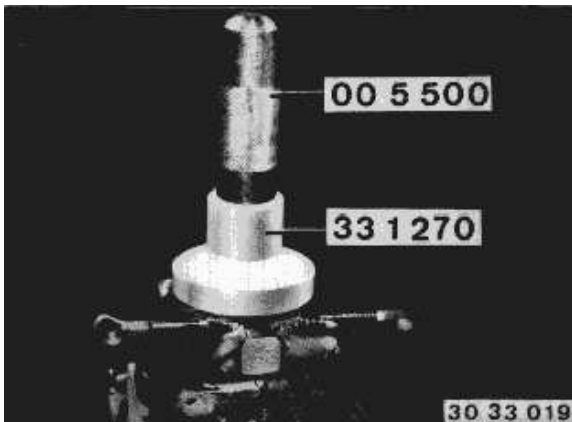

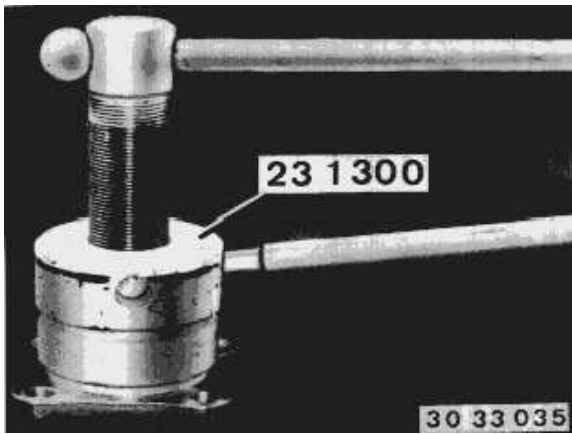

**Installation:**

Press-fit input flange to the input shaft using special tool 23 1 300 but do not tighten down.

The axial preload force of drive pinion bearings (5000 N) can be determined with help of the friction torque.

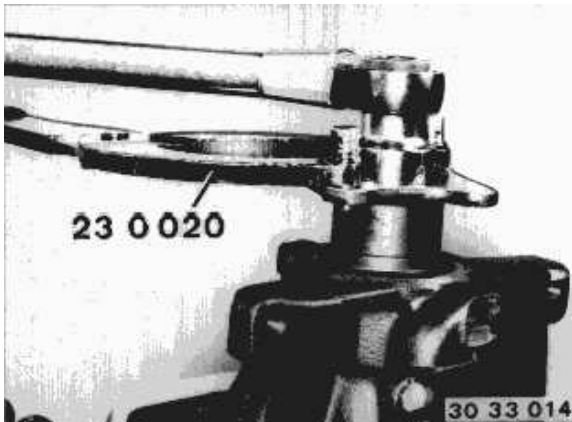

Tighten input flange with the collar nut in steps, measuring the friction torque after each step.

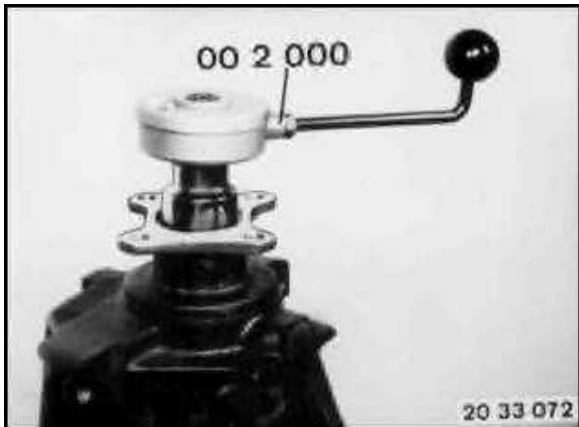

Measure friction torque, refer to Technical Data, with special tool 00 2 000 and suitable socket.

**Caution!**

The relation between friction torque and preload force differs depending on the make of bearings.

To the specified friction torque, refer to Technical Data, add 20 Ncm for the new shaft seal.

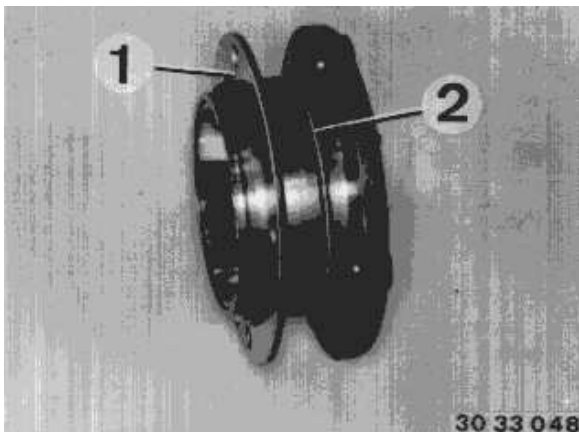

**Installation:**

Install differential, install side cover after marking with the appropriate washers (1) and install new O-rings (2). Tighten screws down evenly.

Tightening torque,

refer to Technical Data 33 11 2AZ.

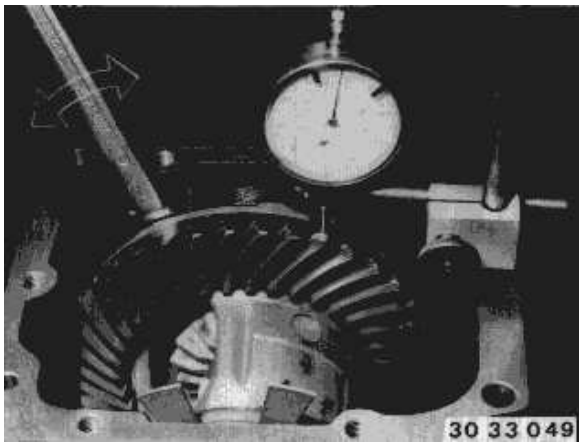

Backlash/tooth contact pattern adjustments  
Secure special tool 00 2 500 (dial gauge holder) and measure backlash, refer to Technical Data.

**Caution!**

The tooth contact pattern is always most important for a perfectly adjusted pinion/crown wheel.

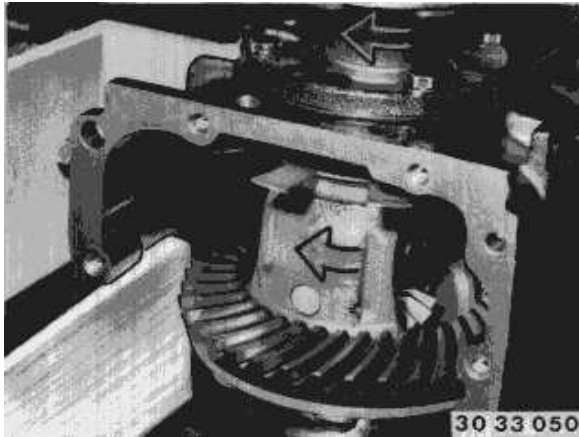

To check the tooth contact pattern, coat the crown wheel teeth with printer's ink, turn in both directions several times and stop crown wheel suddenly with a piece of hard wood.

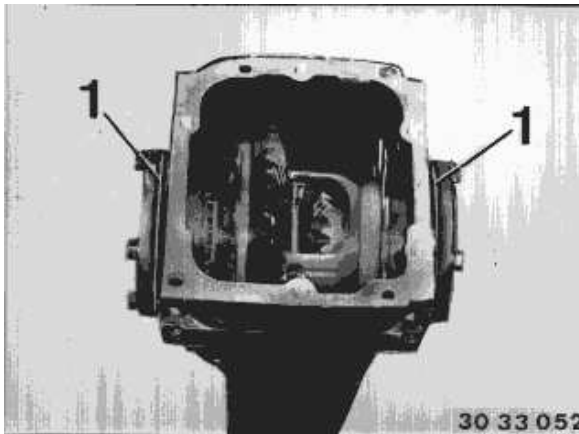

Backlash, refer to Technical Data, and contact pattern are corrected by altering the thicknesses of both shims (1).

If backlash is too great, install a thinner shim on the crown wheel end.

If backlash is too small, use a thicker shim on the crown wheel end.

Axial displacement of the crown wheel of 0.01 mm signifies a change in tooth flank clearance of 0.0076 mm.

**Caution!**

The total thickness of both shims may no longer be changed.

If a thinner or thicker shim is required to correct the tooth contact pattern, the total thickness must be corrected with the second shim, since otherwise the friction torque of bearings would be changed again.



Drive in new retaining plate with special tool 33 4 050 and special tool 00 5 500.

