

Removing and installing tackstrip (operation is described in):

Removing and installing complete convertible cover (Z3 roadster)

refer to 54 31 010

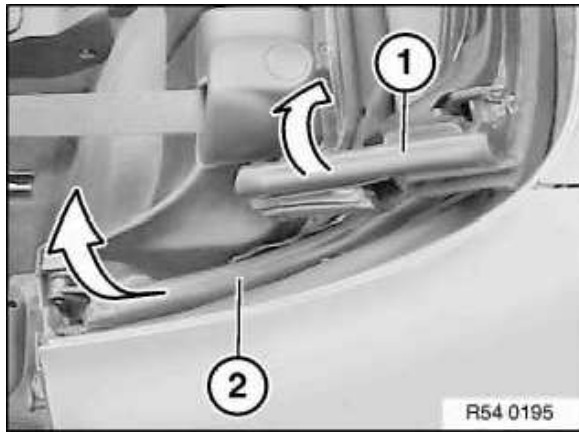

#### Removal:

Remove convertible cover gaskets (1) and (2) on left/right sides.

Raise convertible cover out of convertible top box.

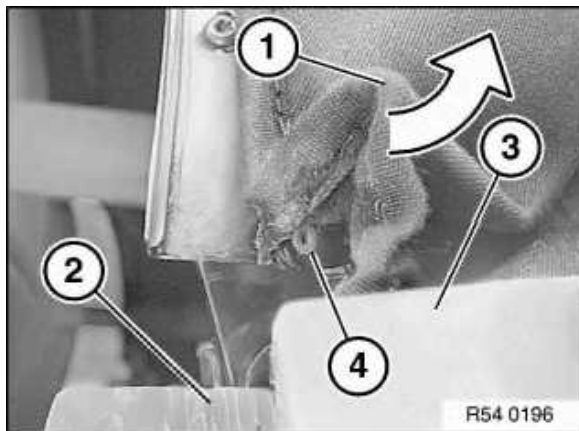

Press convertible cover (1) to one side on B-pillar (2) or raise up out of convertible top box (3).

Unfasten blind rivet (4) on left/right sides from convertible top cover / lower B-pillar bracket (drill out).

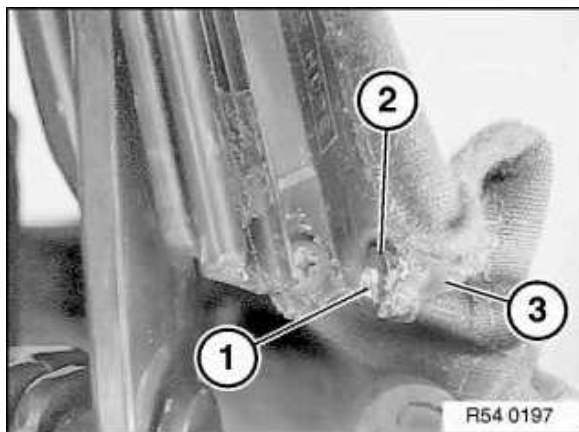

Lift window (2) out of convertible cover / B-pillar bracket (3) on left/right sides.

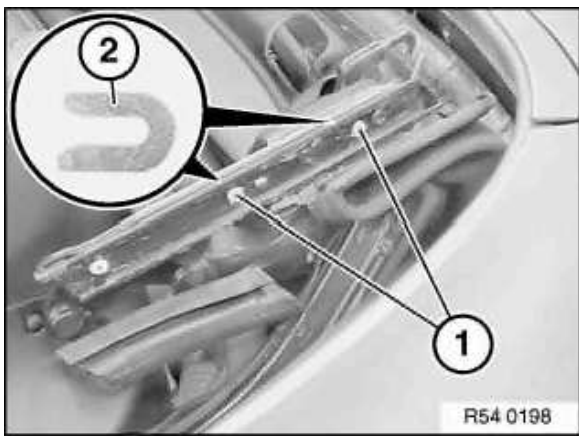

**Note:**

Before unfastening the screws (1), note position and number of spacer discs (2) (if fitted) because same number has to be fitted at the same location (wind noise, leaks).

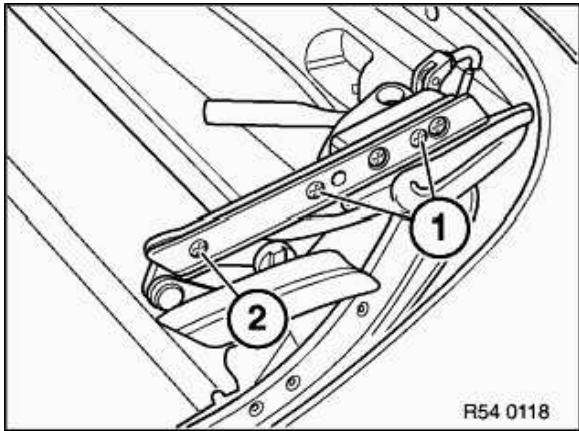

Unscrew bolts (1). Unfasten screw (2) and swivel support rails (for the convertible top gasket) on left/right sides upwards.

**Note:**

Do not unfasten the screw for the interlock frame (adjustment is changed).

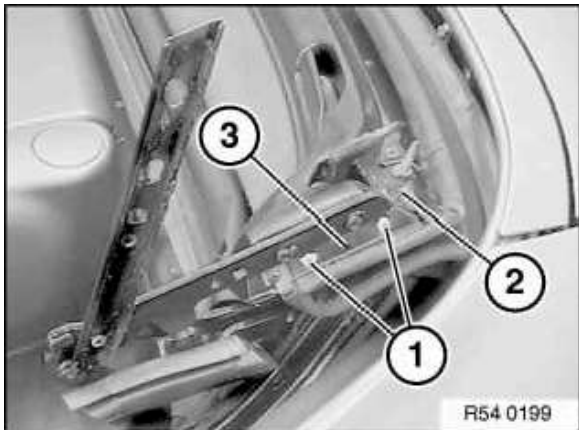

Unfasten screws (1) on left/right windshield bracket (2) and fold tab (3) upwards.

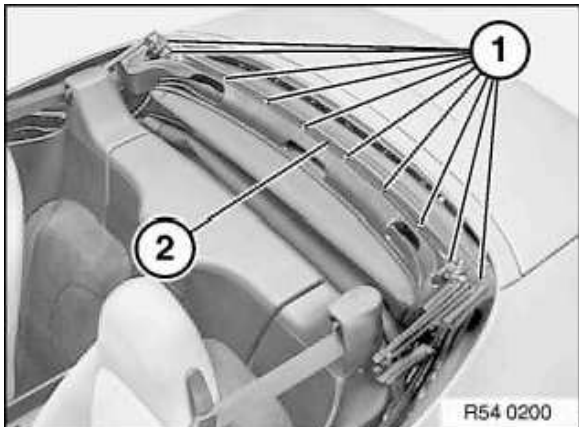

Unscrew bolts (1). Remove frame rail (2) from windshield bracket.

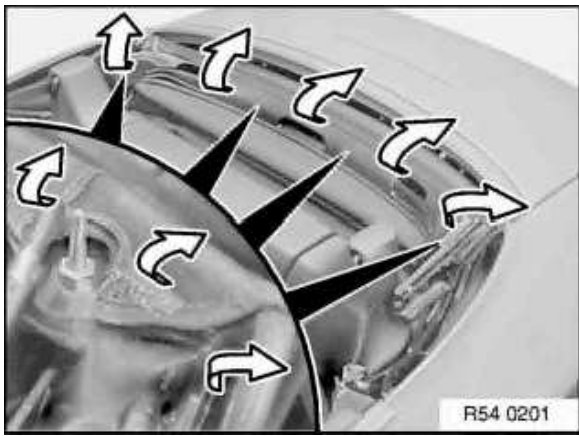

Pull convertible top off cement seal (double-sided adhesive tape, e.g. Tesafix 4965) on front windshield bracket.  
Raise convertible top out of its box.

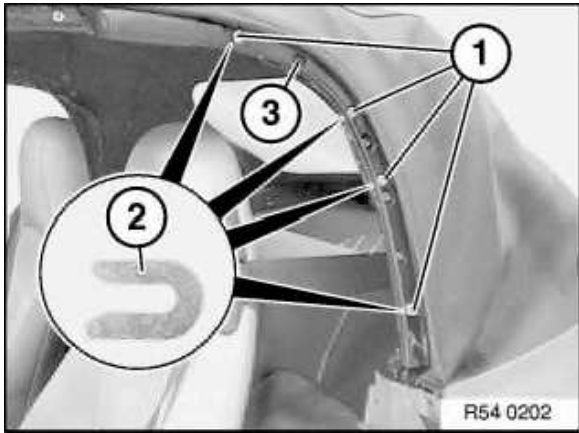

**Note:**

Before unfastening the screws (1), note the position and number of spacer discs (2) (if fitted) because same number has to be refitted at the same location (wind noise, leaks).  
Unfasten screws (1) and remove left/right frame rail (3).

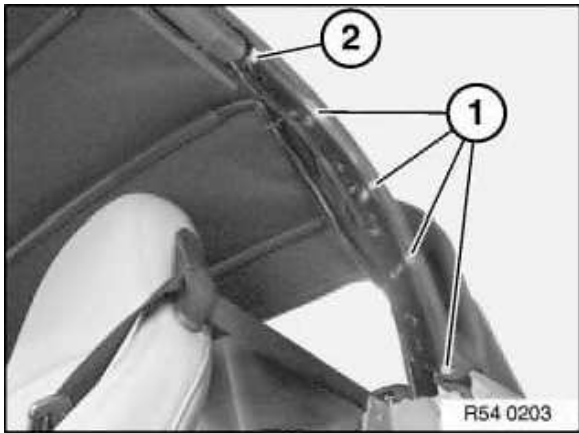

Unfasten left/right screws (1) and rivets (2).

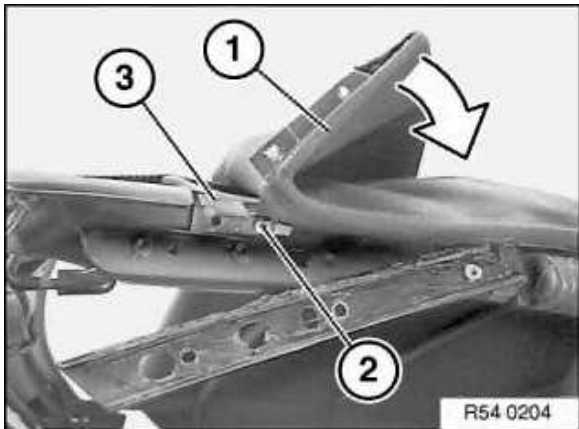

Move front of convertible cover (1) to back. Unfasten screw (1) and unfasten clamp cable bracket (2) from top left/right convertible top linkage.

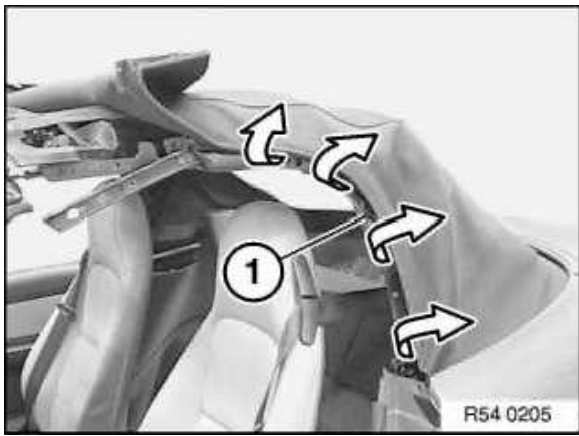

Lift off left/right convertible top (1).

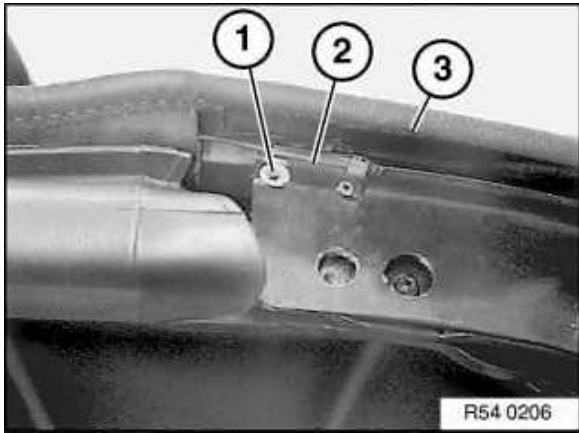

Unfasten screw (1) and remove clamp cable bracket (2).  
Bend clamp cable bracket (2) upwards and pull clamping cable forwards out of convertible cover (3).

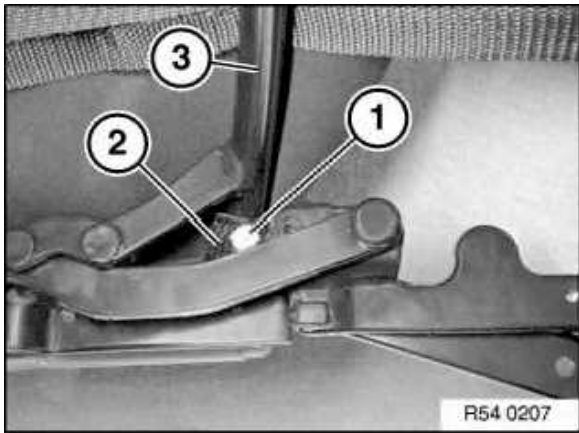

Slightly raise front of convertible cover. Unfasten left/right screw (1) and unfasten side retaining strap (2) on center bracket (3).

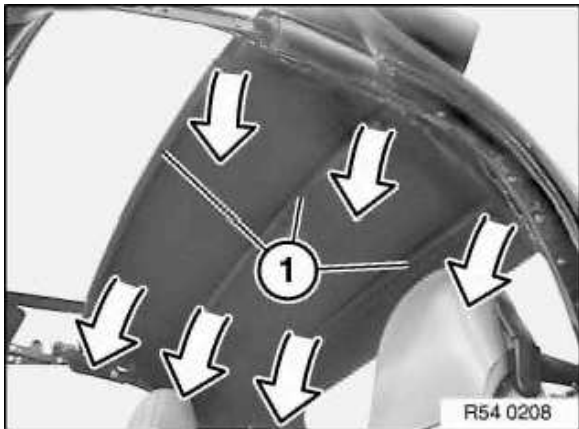

Remove tensioning rail (1) from the brackets.  
Unfasten convertible strap from the brackets.  
Fold convertible cover backwards into convertible top box.

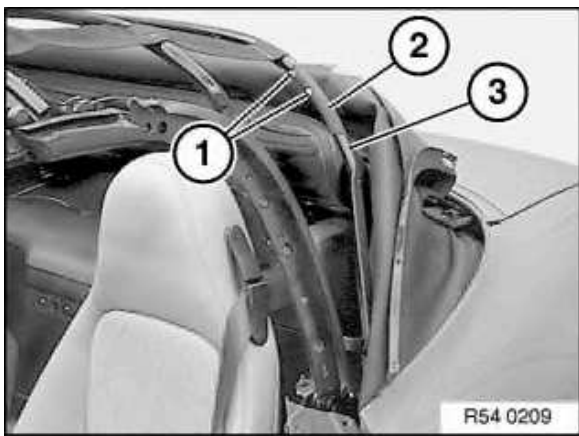

Unfasten blind rivets (1) on clamping cable mount (2) of left/right rear bracket (3).

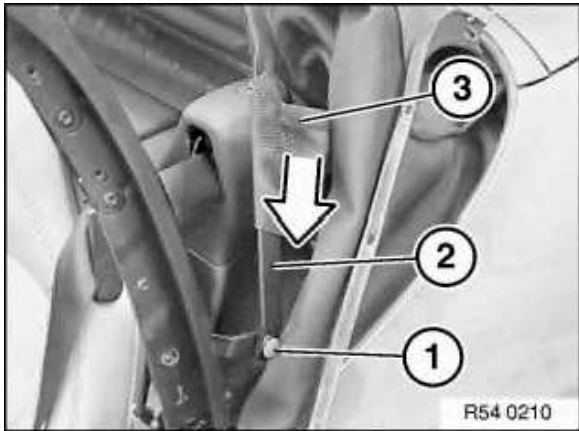

Unfasten screw (1) on joint of rear bracket (2).  
 Remove clamping cable straps (3) on left and right and remove from bracket (2).  
 Place bracket (2) forwards over the convertible top linkage (risk of damage).

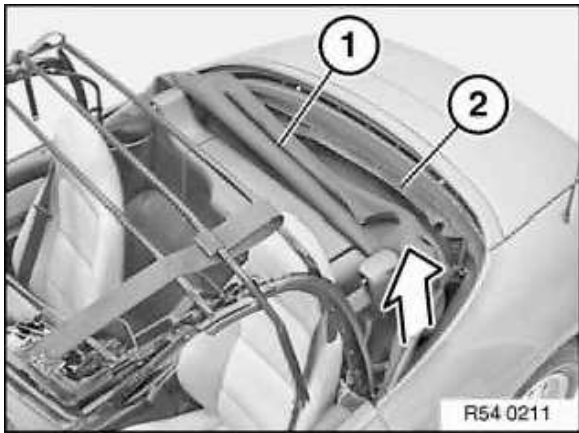

Lift convertible cover (1) with tackstrip (2) on one side and remove from convertible top box.

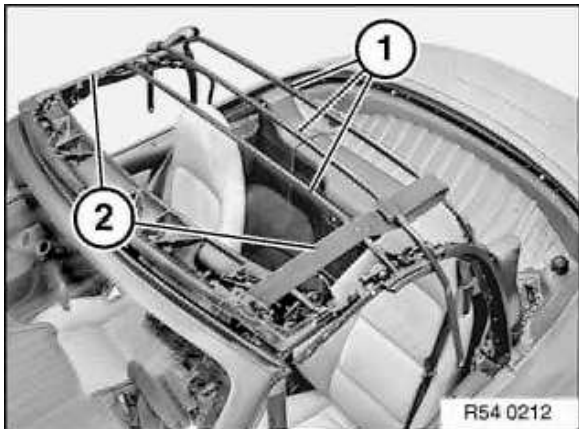

Remove cement residue from the brackets (1) between the clamping straps (2) (clean).

**Installation:**

Install new convertible cover with tackstrip in the convertible top box (2-man operation).

Slide clamping belt loops on left/right sides over the brackets.

Screw down bracket on left/right joints, installing screws with screw locking varnish.

Rivet left/right clamping belts on brackets (hole pattern in clamping belt is specified).

Place cover over convertible top linkage.

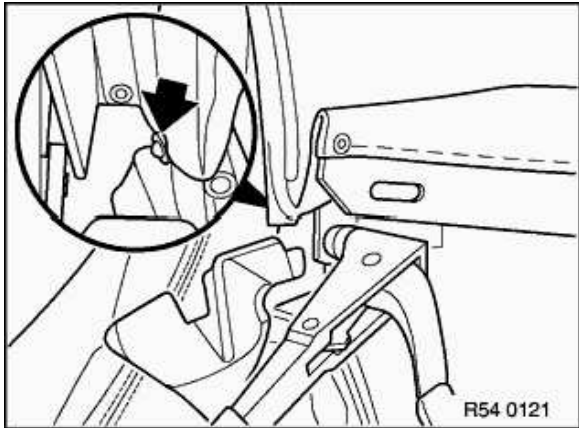

Fit blind rivet with washer to left/right sides of convertible cover/B-pillar bracket.

Fit rivet from outside => convertible cover, bracket, washer.

**Note:**

If necessary, replace the damaged gasket under the tackstrip.

Screw down tackstrip in convertible top box (operation is described in):

Removing and installing complete convertible top (Z3 roadster), refer to 54 31 010

Install clamping cables with brackets (to screw down, windshield bracket should be vertical).

Attach convertible cover on left/right sides to B-pillar bracket.

Install screw in top left/right on the convertible top/B-pillar bracket.

Stow convertible top in its box.

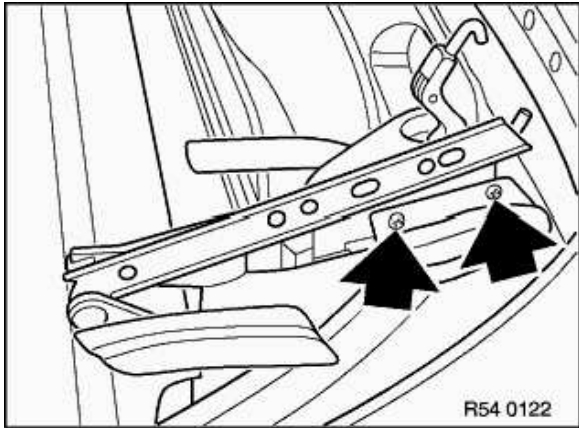

Install side cover mount on windshield brackets at left/right sides.

Remove protective paper from double-sided adhesive tape, move convertible cover over front of windshield bracket and secure (position is specified by hole pattern).

Screw down frame rail on windshield bracket.

Screw down left/right frame rails on convertible top gasket.

Fit left/right frame rails for the convertible top gasket.

#### **Caution!**

The washers are refitted in the same location as noted during disassembly.

Close and lock soft top.

Cement convertible tabs to the brackets.

Clip tensioning rail onto the brackets.

Fit convertible top gaskets to each side.

Fit edge protector on B-pillar/side panel.

**Note:**

The dimensions and tolerances for the convertible top linkage and cover are designed in such a way that no tension correction is required. For an initial period after assembly, new convertible tops are always rather "tight". If the vehicle is parked for an extended period (e.g. over night) with the convertible top closed, the convertible top "settles" and the closing forces return to normal.

**Caution!**

If the convertible top is too tense, the locking forces rise and the convertible top also adopts the properties of a "drum". The wind forces exerted on the vehicle while in motion and the action of raindrops "beat down" in a drum-like fashion on the top and substantially impair interior acoustics. On the other hand, if the convertible top is not tense enough, "it droops" and, at higher roadspeeds, it starts to make a "banging noise".